

Hydra-Rester®

Commercial Water Hammer Arrester

CPVC & PEX
NEW
CONNECTIONS

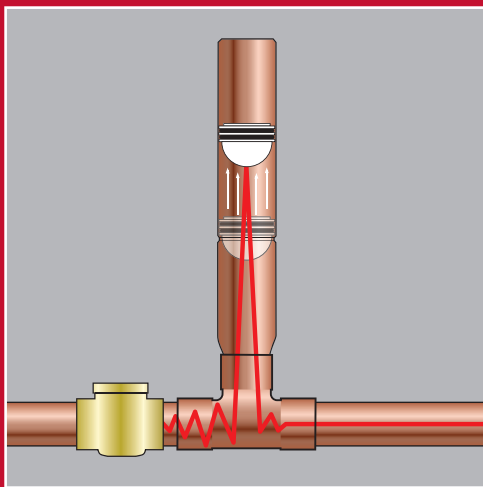

- **PEACE OF MIND**
Tested, approved, and certified
- **SAFE**
Keeps pressure surges below 150 PSI
- **LONGEVITY**
500,000 cycles strong
- **ASSURANCE**
Lifetime guaranteed

ASSE
1010



Supply • Drainage • Support • Testing • Specialties • Tools • Access

**Sioux
Chief** 
MANUFACTURING SINCE 1957

What is Water Hammer?

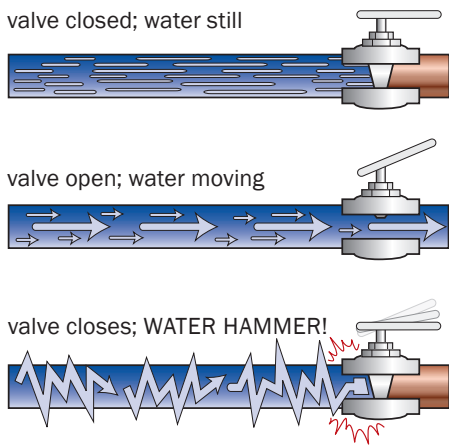

Although water hammer is a subject usually left up to plumbing engineers, the effects of water hammer must be dealt with every day by plumbing contractors everywhere. Water hammer is easily recognized by the banging or thumping noise that's heard when valves are shut off. Although this is an easy way to recognize the problem, water hammer doesn't always make these telltale noises. Water hammer occurs when the flow of moving water is suddenly stopped by a closing valve. This sudden stop results in a tremendous spike of pressure behind the valve which acts like a tiny explosion

inside the pipe. This pressure spike reverberates throughout the plumbing system, rattling and shaking pipes, until it is absorbed. Normally, a sufficient pocket of air will absorb such a pressure spike, but if no pocket of air is present, expensive fixtures and appliances within the plumbing system will be damaged as they are left to absorb this pressure spike.

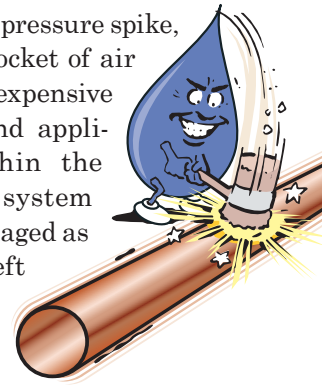

Why Air Chambers Don't Work

It used to be thought that an air chamber, or capped stand pipe, was an effective solution to controlling water hammer. However, within an air chamber, nothing separates the air from the water. It only takes a few short weeks before the air is absorbed into the water, leaving the air chamber waterlogged and completely ineffective. Laboratory tests confirm that the air is depleted by simple air permeation and by interaction between static pressure and flow pressure. In the diagram shown, (right) notice the difference in water level between "Static Line Pressure" and "Post-Cycle Static Level."

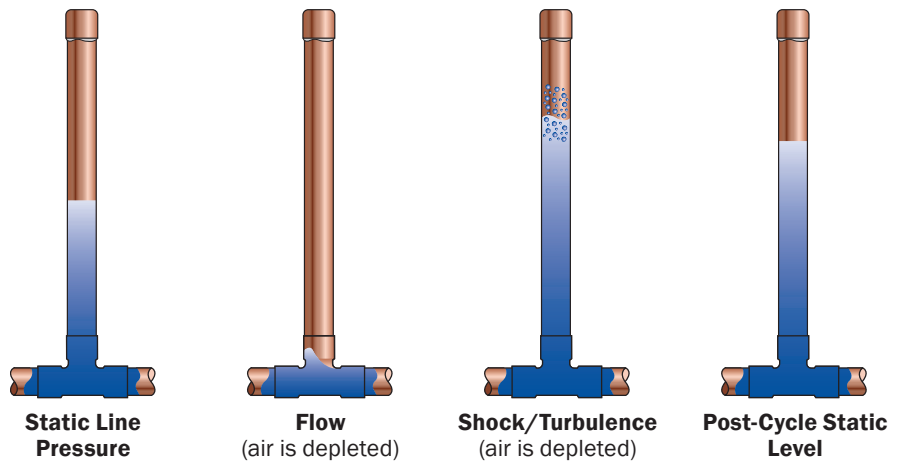

Controlling Water Hammer

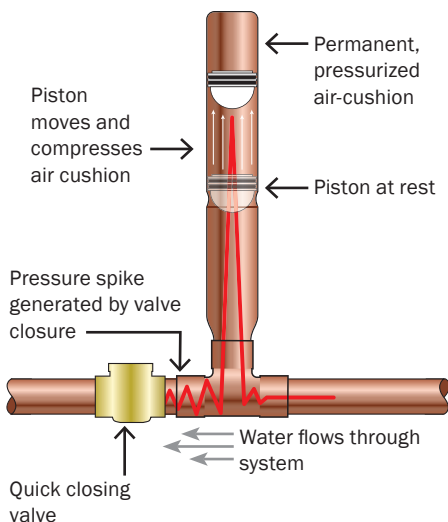

The most effective means of controlling water hammer is a measured, compressible cushion of air which is permanently separated from the water system. Sioux Chief arresters employ a pressurized cushion of air and a two o-ring piston, which permanently separates this air cushion from the water system. When the valve closes and the water flow is suddenly stopped, the pressure spike pushes the piston up the arrester chamber against the pressurized cushion of air. The air cushion in the arrester reacts instantly, absorbing the pressure spike that causes water hammer. Although arresters are typically tested to 10,000 cycles, Sioux

Chief arresters have been independently lab tested to withstand 500,000 cycles without failure. All Sioux Chief arresters are guaranteed to control water hammer for the lifetime of the plumbing system.

For more information about controlling water hammer see our Engineer Report or our Water Hammer FAQ brochure. Call or visit our website to request a copy.

Sizing and Placement

Fixture	Type of Supply Control	Fixture Units					
		Public			Private		
		Total	C.W.	H.W.	Total	C.W.	H.W.
Water closet	Flush valve	10	10	—	6	6	—
Water closet	Flush tank	5	5	—	3	3	—
Pedestal urinal	Flush valve	10	10	—	—	—	—
Stall or wall urinal	Flush valve	5	5	—	—	—	—
Stall or wall urinal	Flush tank	3	3	—	—	—	—
Lavatory	Faucet	2	1½	1½	1	1	1
Bathtub	Faucet	4	2	3	2	1½	1½
Shower head	Mixing valve	4	2	3	2	1	2
Bathroom group	Flush valve closet	—	—	—	8	8	3
Bathroom group	Flush tank closet	—	—	—	6	6	3
Separate shower	Mixing valve	—	—	—	2	1	2
Service sink	Faucet	3	3	3	—	—	—
Laundry tubs (1-3)	Faucet	—	—	—	3	3	3
Combination fixture	Faucet	—	—	—	3	3	3

The fixture unit values shown in this table represent the standard ratings used by engineers to size water distribution systems as well as water hammer arresters. Match fixture units in the table to the Hydra-Rester with the corresponding fixture unit value.

Example

Cold Water
Equal to 26 Fixture Units
Requires - **B Unit**
Sioux Chief 653-B series

Hot Water
Equal to 6 Fixture Units
Needs - **A Unit**
Sioux Chief 652-A series

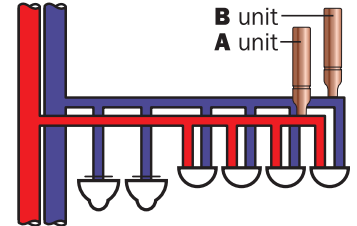

Multi-Fixture Branch Lines

Rule 1: Branch Lines of 20 Feet or Less The Hydra-Rester should be placed at the end of the branch line within six feet of the last fixture served, as shown (right). Select required model using fixture unit sizing (above). Always place arrester within six feet of the last fixture.

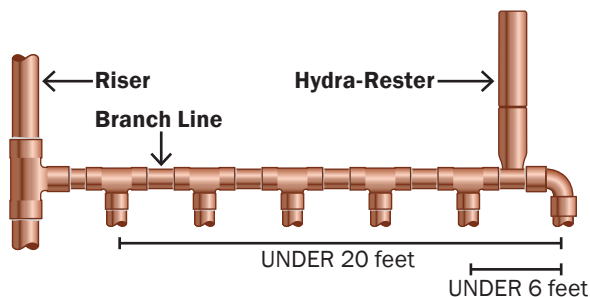

Rule 2: Branch Lines Over 20 Feet An additional Hydra-Rester (Y) should be placed as shown (right). The additional unit should be placed at the midpoint of the run longer than 20 feet. Select required model(s) using fixture unit sizing (above). The sum of the fixture unit ratings of units X and Y combined, shall be equal to or greater than the demand of all branches.

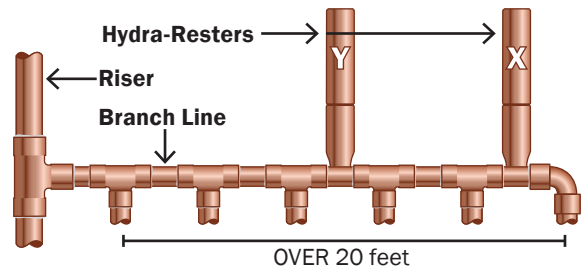

Long Runs of Piping to Remote Equipment

When long runs of piping serve remote equipment, we recommend custom sizing for each specific application. If you have such an application, fill out our arrester sizing form on the next page and fax it to us. Your specific job will be analyzed and calculated by our sizing program. The results will be sent to you, including the required arrester size and information on how to order.

Residential Installations

For High-Flow Garden Tub Valves and Multi-Head Shower Valves, install 653-B Hydra-Resters on both hot and cold supply lines within six feet of the valve.

For Lawn Irrigation Zone Valves, on ¾" service line, install one 653-B Hydra-Rester within six feet of each valve or group of valves. On 1" service line: Install one 654-C Hydra-Rester within six feet of each valve or group of valves.

Water Hammer Arrester Cross Reference

Manufacturer (Trade Name)	Arrester Size						
	AA	A	B	C	D	E	F
Sioux Chief (Mini-Rester, Hydra-Rester)	660 Series	652-A	653-B	654-C	655-D	656-E	657-F
Josam (Absorbotron)	—	75001	75002	75003	75004	75005	75006
J.R. Smith (Hydrotrol)	—	5005	5010	5020	5030	5040	5050
PPP (MM, SC Series)	MM-500 Series	SC500	SC750	SC1000	SC1250	SC1500	SC2000
Wade (Shokstop)	—	W-5	W-10	W-20	W-50	W-75	W-100
Watts (05, 15 Series)	05 Series	15 - ½"	15 - ¾"	15 - 1"	15 - 1¼"	15 - 1½"	15 - 2"
Zurn (Shoktrol)	—	100	200	300	400	500	600

Hydra-Rester®

Commercial Water Hammer Arrester

Certified by the American Society of Sanitary Engineering to the ANSI/ASSE 1010-2004 Standard.

Lifetime cycle tested at U.S. Testing Laboratories in Fairfield, NJ, to withstand 10,000 shock cycles. Factory tested to withstand 500,000 cycles, without failure. (654-C tested)

Compact Size

Allows for installation in a 2 × 4 wall cavity.

Installation Angle

Install upright, horizontally, or any angle in between.

Sealed Wall Installation

Approved for installation with no access panel required.

Press-Fit Compatible

Hydra-Rester male sweat fittings are compatible with all press-fitting systems, such as Viega ProPress™, and push-fitting systems, such as Cash Acme SharkBite™.

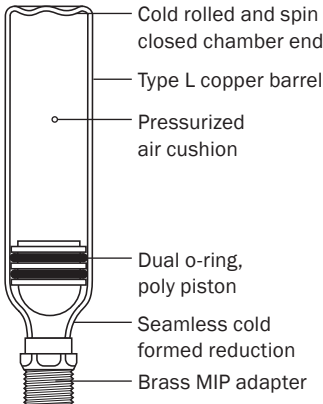
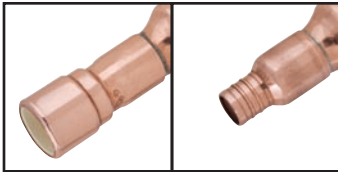

SPECIFICATIONS

Maximum Working Temp	250°F
Safe Working Pressure for Pressure Testing	350 PSIG
Burst Tested	2,900 PSIG



Sioux Chief has a complete line of water hammer arresters

◀ Mini-Rester™

Residential Water Hammer Arrester

Mega-Rester™ ▶

Industrial Water Hammer Arrester



Item No.	Conn. Size	Unit Size	Dimensions		Fixture Unit Value	Cubic Inch Volume	Pkg	Min. Qty	Case Qty
			Length	Width					
MIP THREAD									
652-A	½"	A	6½"	1⅜"	1-11	5	B	1	16
653-B	¾"	B	8¾"	1⅜"	12-32	7	B	1	16
654-C	1"	C	11"	1⅜"	33-60	11	B	1	16
655-D	1"	D	10⅞"	2⅝"	61-113	20	B	1	4
656-E	1"	E	12⅝"	2⅝"	114-154	29	B	1	4
657-F	1"	F	15⅞"	2⅝"	155-330	36	B	1	4
MALE SWEAT									
652-AS	½"	A	8¾"	1⅜"	1-11	5	B	1	16
653-BS	¾"	B	10"	1⅜"	12-32	7	B	1	16
654-CS	1"	C	12½"	1⅜"	33-60	11	B	1	16
655-DS	1"	D	11"	2⅝"	61-113	20	B	1	4
656-ES	1"	E	13½"	2⅝"	114-154	29	B	1	4
657-FS	1"	F	16"	2⅝"	155-330	36	B	1	4
CPVC SOCKET ASTM D 2846 †									
652-AC	½"	A	7½"	1⅜"	1-11	5	B	1	16
653-BC	¾"	B	9½"	1⅜"	12-32	7	B	1	16
654-CC	1"	C	12"	1⅜"	33-60	11	B	1	16
PEX CRIMP ASTM F 1807 †									
652-AX	½"	A	6½"	1⅜"	1-11	5	B	1	16
653-BX	¾"	B	8¾"	1⅜"	12-32	7	B	1	16
654-CX	1"	C	11"	1⅜"	33-60	11	B	1	16

† NOTE: PEX and CPVC connection specifications are limited to those called out in their respective ASTM Standards for Fittings.

24110 South Peculiar Drive
Peculiar, Missouri 64078
tel: 1-800-821-3944
fax: 1-800-758-5950
www.siouxchief.com

